



Combinazioni modelli & tessuti per divani / Grid of models & fabrics for sofas

 **TIRELLA TESSUTI CONSIGLIATA**
SUGGESTED FABRIC HANGER

Il numero rosso indica lo specifico tessuto sconsigliato all'interno della tirella.
The number of fabric within the fabric hanger shown in red, is not recommended.

 **TIRELLA TESSUTI SCONSIGLIATA**
NOT RECOMMENDED FABRIC HANGER

Il numero verde indica lo specifico tessuto consigliato all'interno della tirella.
The green numbers show the suggested specific fabrics within the fabric hanger.

 **TIRELLE SENZA INDICAZIONI SPECIFICHE**
NO SPECIFIC INSTRUCTIONS

E' necessario prestare attenzione alle indicazioni tecniche e sartoriali riportate sulle stesse.
Please refer to labels shown on the fabric samples.

98 Hip Bazaar **1**
Divina - Divina Melange
Tonus
Hallingdal
Stamskin Top - Extrema
Alcantara

71 Mohair & Velluti / Velvets
73 Grainderiz
81 Uniforms
87 Washables **1**
90 Superwhites
91 FIT
92 Polyrock **2/7**
93 Remix **3/5**
94 Timeless
4,8 only cushion
96 Floribunda II
97 Metropolitan
99 Structures
100 Cross Over 1
101 Cross Over 2
102 The Specials **7/6/3**
103 My Tip
104 Net - Work
Pelle Z / Leather Z

95 Floribunda I **13**
Pelle T / Leather T

Per il rivestimento in pelle cliente, si prega di contattare il Ns ufficio commerciale.
Per qualsiasi richiesta particolare non prevista, si prega di contattare il Ns Ufficio commerciale.
For C.O.L. requests, please contact your sales rep. our sales office in Italy.
For specific questions or requests, please contact your sales rep. or our sales office in Italy.



Combinazioni modelli & tessuti per poltrone / Grid of models & fabrics for armchairs

 **TIRELLA TESSUTI CONSIGLIATA**
SUGGESTED FABRIC HANGER

Il numero rosso indica lo specifico tessuto sconsigliato all'interno della tirella.
The number of fabric within the fabric hanger shown in red, is not recommended.

92 Polyrock **5/6**
95 Floribunda I
98 Hip Bazaar **1**
Divina - Divina Melange
Tonus
Hallingdal
Stamskin Top - Extrema
Pelle T / Leather T
Pelle Z / Leather Z

 **TIRELLA TESSUTI SCONSIGLIATA**
NOT RECOMMENDED FABRIC HANGER

Il numero verde indica lo specifico tessuto consigliato all'interno della tirella.
The green numbers show the suggested specific fabrics within the fabric hanger.

71 Mohair & Velluti / Velvets
73 Grainderiz
81 Uniforms
87 Washables **1**
90 Superwhites
91 FIT
93 Remix **3/5**
96 Floribunda II
97 Metropolitan
99 Structures
100 Cross Over 1
101 Cross Over 2
102 The Specials **3**
103 My Tip
104 Net - Work
Alcantara

 **TIRELLE SENZA INDICAZIONI SPECIFICHE**
NO SPECIFIC INSTRUCTIONS

E' necessario prestare attenzione alle indicazioni tecniche e sartoriali riportate sulle stesse.
Please refer to labels shown on the fabric samples.

94 Timeless
4,8 only cushion

Per il rivestimento in pelle cliente, si prega di contattare il Ns ufficio commerciale.
Per qualsiasi richiesta particolare non prevista, si prega di contattare il Ns Ufficio commerciale.
For C.O.L. requests, please contact your sales rep. our sales office in Italy.
For specific questions or requests, please contact your sales rep. or our sales office in Italy.

Materiale e finiture / Materials and Finishings / Materialien und Ausführungen / Matériaux et Finitions

Colori Little Albert / Little Albert colors / Farben Little Albert / Couleurs Little Albert



Verde
Green
Grün
Vert



Verde acido
Fluo green
Fluo grün
Vert fluò



Arancio
Orange
Orange
Orange



Rosso
Red
Rot
Rouge



Fucsia
Fuchsia
Fucsia
Fucsia



Nero
Black
Schwarz
Noir

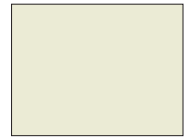

Bianco traslucido
Traslucid white
Durchscheinend weiss
Blanc translucide

Little Albert laccato lucido / Little Albert high gloss lacquered / Little Albert lackiert hochglanz / Little Albert laqué brillant



Bianco
White
Weiss
Blanc



Nero
Black
Schwarz
Noir



Argento
Silver
Silber
Argent



Rosso
Red
Rot
Rouge



Arancio
Orange
Orange
Orange

Le finiture qui riprodotte sono indicative. Leggeri scostamenti non verranno accettati come reclamo.
Finishings may slightly change. Light differences will not be accepted as complaint.
Farbabweichungen gegenüber den Mustern sind möglich und müssen akzeptiert werden.
Les couleurs reprises sur cette page sont indicatives et de légères différences ne seront pas acceptées comme non-conformités.

Prove tecniche Little Albert / Technical test Little Albert / Technische Proben Little Albert / Essais Techniques Little Albert

UNI 9429/89.....Max level 5

UNI 9427/89.....Max level 5

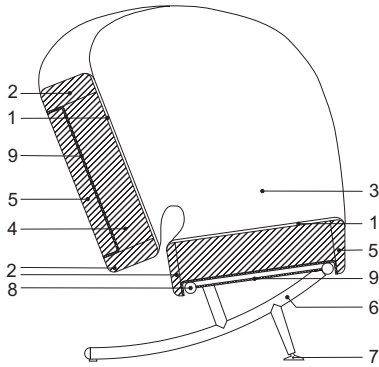

Attenzione Le dimensioni dei divani 047 - 048, possono dare problemi nel passaggio di aperture, ascensori, scale, ecc.ecc....
 Little Albert (cod.042) ordine minimo: 4 pezzi dello stesso colore.
 Imballaggio (cod. 03W - 03V) : 2 tavoli stesso colore e altezza.

Attention For sofas 047 - 048 check dimensions of doors, elevators, staircases,etc., to allow delivery.
 Little Albert (cod.042) minimum quantity: 4 pieces, same color.
 Tables (cod. 03W - 03V): minimum quantity: 2 tables same color and height (surcharge for single table order).

Achtung Bitte beachten sie die Masse der Sofas 047 - 048 Probleme mit Tueren, Aufzuege, Treppen, ecc.ecc....
 Little Albert (Kod.042) Bestellung mindestens 4 stueck, gleiche Farbe.
 Verpackung (Kod. 03W - 03V) : 2 Tischen, gleiche Farbe und Höhe.

Attention Verifiez les dimensions des canapé 047 - 048 pour passer les portes, ascenseurs, escalier, etc.etc....
 Little Albert (cod.042) commande quantité minimum 4 pieces, même couleur.
 Emballage (cod. 03W - 03V) : 2 tables, même couleur et même hauteur.

Legenda - Description

- 1 Tela di cotone 100%
100% cotton cover
Überzug aus Baumwollstoff
Mélange de coton 100%
- 2 3 - 4 - 5: Poliuretani a densità e portanza differenziate
3 - 4 - 5: Polyurethane foam in varied densities
3 - 4 - 5: Polyurethanschaum in untersch. Raumdichtigkeiten
3 - 4 - 5: Mousse polyuréthane à densités différenciées
- 6 Piede in acciaio verniciato
Legs varnished steel
Füss aus verchromtes Stahl
Pied en acier verni
- 7 Sottopiede regolabile cromato
Adjustable glide metal with chrome finish
Verstellbarer verchromt. Unterfüß
Sous-pied chromé réglable
- 8 Struttura in acciaio
Steel frame
Stahlstruktur
Structure en acier
- 9 Struttura in resina poliestere
Polyester resin structure
Polyesterfasem
Structure en resin de polyester

Struttura

Resina rinforzata con fibra di vetro completa di supporto in acciaio rivestita in poliuretano espanso indeformabile a densità differenziate. Piedi in acciaio verniciato. Le poltroncine (cod. 061 - 0V8) sono in espanso schiumato a freddo ignifugo, con struttura interna in acciaio. La poltroncina girevole (cod. 0V8) ha il basamento in acciaio verniciato nero. La poltroncina LITTLE ALBERT (cod. 042) e i TAVOLI hanno la struttura in polietilene riciclato tinto in massa ottenuto mediante stampaggio rotazionale. I colori disponibili per la LITTLE ALBERT sono: bianco traslucido, nero carbone, arancio, rosso lampone, fucsia, verde e verde acido mentre per i TAVOLI i colori sono: bianco traslucido e rosso. Resistenti alla luce e all'acqua. I colori disponibili per la LITTLE ALBERT versione LACCATA (cod. 161) sono bianco Ral 9003, nero Ral 9004, rosso, argento e arancio.

Sovrapprezzi

La vendita di un singolo tavolo comporta un aum. del 5 %.

Caratteristiche

La coll. VICTORIA AND ALBERT è sfoderabile. In pelle è fissa. La poltroncina LITTLE ALBERT e i TAVOLI possono essere usati anche all'esterno esclusa la versione laccata.

Structure

Stress-resistant polyurethane foam in varied densities over fiberglass-reinforced resin structure with steel support. Base/legs are varnished steel. Small armchairs (cod. 061 - 0V8) are injected flame-retardant polyurethane foam over internal steel frame. Swivel armchair (cod. 0V8) base is steel with black varnished finish. Small armchair LITTLE ALBERT (cod. 042) and TABLES are rotationally molded, integrally colored polyethylene. Available colors for LITTLE ALBERT chair: translucent white, carbon black, orange, red raspberry, fuchsia, green and fluo green. For TABLES: translucent white and red only. Waterproof and fade resistant.

Surcharge

Surcharge for single table order + 5%.

Spec. Characteristics

VICTORIA AND ALBERT fabric covers are removable. Leather covers are fixed. Small armchair LITTLE ALBERT (cod. 042) and TABLES are suitable for outdoor use.

Struktur

Polyesterfasern mit Stahlstruktur mit unverformbarem Polyurethanschaum in unterschiedlichen Raumdichtigkeiten gepolstert. Füsse aus lackiert Stahl. Sessel (Kod. 061 - 0V8) bestehen aus einem Stahlgestell in feuerhemmendem kaltgeschäumtem Schaumstoff. Drehsessel Klein (cod. 0V8) mit Untergestell aus Stahl schwarz lackiert. Sessel LITTLE ALBERT (Kod. 042) und TISCHE bestehen aus Eingefaerbtess Polyethylen durch Drehspritzgießen. Farben Palette für LITTLE ALBERT Sessel sind: durchscheinend weiss, schwarz Kohle, orange, himbeerrot, fucsia, gruen und fluogruen, für TISCHE: nur durchscheinend weiss und rot. Farben Palette für LITTLE ALBERT LACKIERT Sessel (kode 161) sind: weiss Ral 9003, schwarz Ral 9004, rot, silber und orange.

Aufpreis

Die Lieferung nur eines Tisches kosten ein Aufpreis von 5%.

Besonderheiten

Kollektion VICTORIA AND ALBERT ist abziehbar. Lederausführung ist fix. Der sessel LITTLE ALBERT und TISCHE können auch in Aussenbereiche verwendet werden, mit Ausnahme der lackierten Ausführung.

Structure

Resin renforcée avec fibre de verre avec support en acier recouverte de mousse polyuréthane indéformable à densités différentes. Pieds en acier verni. Petit fauteuils (cod. 061 - 0V8): stucture en acier enrobée dans de la mousse ignifugée injectée à froid. Petit fauteuil pivotant (cod. 0V8) avec base en acier vernis noir. Le petit fauteuil LITTLE ALBERT (cod. 042) et TABLES ont une structure en polyéthilène teinté avec moule rotationnel. Couleurs disponibles pour la LITTLE ALBERT: blanc translucide, noir charbon, orange, rouge framboise, fucsia, vert et vert fluò. Pour les TABLES seulement blanc translucide et rouge. Résistant à la lumière et à l'eau. Couleurs disponibles pour la LITTLE ALBERT LAQUEE' (cod. 161): blanc Ral 9003, noir Ral 9004, rouge, argent et orange.

Suppl. de prix

La vente d'une seule table comporte une augmentation du prix de 5 %.

Caractéristiques

La collection VICTORIA AND ALBERT est déhoussable. En cuir, fixe. La petit fauteuil LITTLE ALBERT et TABLES peuvent être utilisés à l'extérieur, excepté la version laquée.

 **Fodera**
Ersatzbez Cover
Housse

 m **Tessuto**
Stoff Fabric
Tissu

 m² **Pelle**
Leder Leather
Cuir

 Kg **P. lordo**
Bruttogew. Gr. Weight
Poids Brut

 m³ **Volume**
Volumen Volume
Volume

Cod. 061

Poltroncina

Small armchair
Sessel Klein
Petit fauteuil

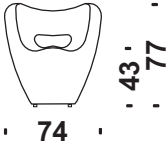

profondita' 65
depht 65

 m 3,1  m² 6,0  Kg 25  m³ 0,44

Cod. 0V8

Poltrona girevole

Revolving small armchair
Drehessel-Klein
Petit fauteuil pivotant

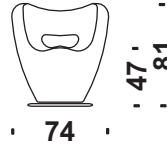

profondita' 65
depht 65

 m 3,1  m² 6,0  Kg 33  m³ 0,44

Cod. 044

Divano da 200

Sofa 200
Sofa 200
Canapé 200

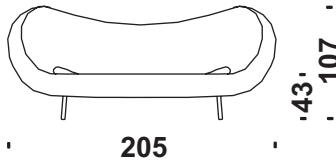

profondita' 95
depht 95

 m 7,0  m² 14,5  Kg 66  m³ 1,90

Cod. 045

Divano da 250

Sofa 250
Sofa 250
Canapé 250

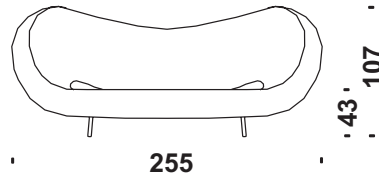

profondita' 95
depht 95

 m 9,0  m² 18,2  Kg 82  m³ 2,10

Cod. 047

Divano da 290 destro

Sofa 290 right
Sofa 290 rechts
Canapé 290 droit

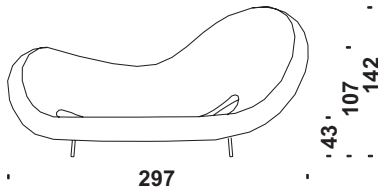

profondita' 125
depht 125

 m 12,5  m² 25,0  Kg 101  m³ 3,70

Cod. 048

Divano da 290 sinistro

Sofa 290 left
Sofa 290 links
Canapé 290 gauche

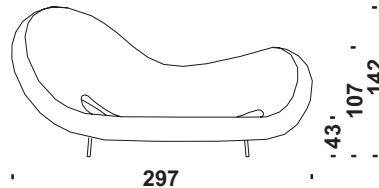

profondita' 125
depht 125

 m 12,5  m² 25,0  Kg 101  m³ 3,70

 **Fodera**
Ersatzbez Cover
Housse

 m **Tessuto**
Stoff Fabric
Tissu

 m² **Pelle**
Leder Leather
Cuir

 Kg **P. lordo**
Bruttogew. Gr. Weight
Poids Brut

 m³ **Volume**
Volumen Volume
Volume

Cod. 001

Poltrona

Armchair
Sessel
Fauteuil

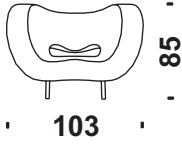

profondita' 85
depht 85

 m 5,0

 m² 9,0

 Kg 35

 m³ 0,70

Cod. 042

LITTLE ALBERT

LITTLE ALBERT
LITTLE ALBERT
LITTLE ALBERT

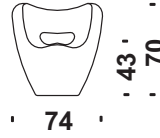

profondita' 62
depht 62

 Kg 17

 m³ 0,37

Cod. 161

LITTLE ALBERT laccata

LITTLE ALBERT lacquered
LITTLE ALBERT lackiert
LITTLE ALBERT laqué

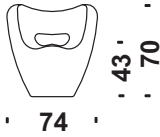

profondita' 62
depht 62

 Kg 17

 m³ 0,37

Cod. 03W

Tavolo alto

Table high
Tisch Hoch
Table haut

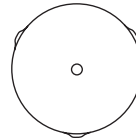
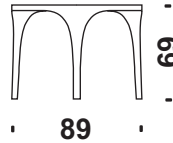

 Kg 10

 m³ 0,70

Cod. 03V

Tavolo basso

Table low
Tisch Tief
Table bas

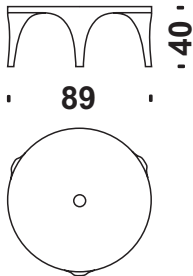

 Kg 9

 m³ 0,40