

Nori Alucompact® DEPTH 80

Designed by Bartoli Studio

Extending or fixed table with an anodised aluminium structure and Alucompact® layered laminate tops. Alucompact® is a laminate that has been layered at a high temperature by adding sheets of aluminium in the layering phase that give it a strong structural stability. The extending mechanism with two or three extensions makes it possible to easily increase the length of the top while maintaining excellent sturdiness.

Leg finish:

- Anodised aluminium
- Aluminium with white lacquer
- Aluminium with sand grey lacquer
- Aluminium with anthracite grey lacquer
- Aluminium with black lacquer

Finish of top/extensions:

- White laminate
- Sand grey laminate
- Grey laminate
- Anthracite grey laminate
- Black laminate

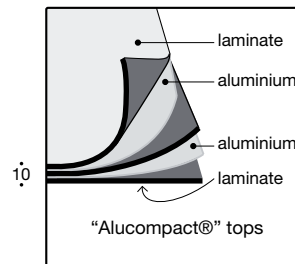

Extensible (↔)

Code	Length (cm.)	Finish of legs	Finish of top	Vol.
01NOR01	114-154-194	aluminium	laminate	0.27
		lacquer	laminate	
01NOR02	139-179-219	aluminium	laminate	0.32
		lacquer	laminate	

Nr. packages 3

Fixed (||)

Code	Length (cm.)	Finish of legs	Finish of top	Vol.
01NOR01F	114	aluminium	laminate	0.24
		lacquer	laminate	
01NOR02F	139	aluminium	laminate	0.28
		lacquer	laminate	

Nr. packages 1

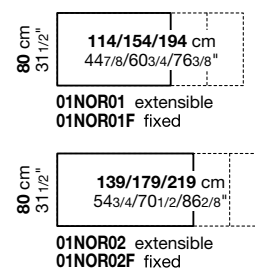
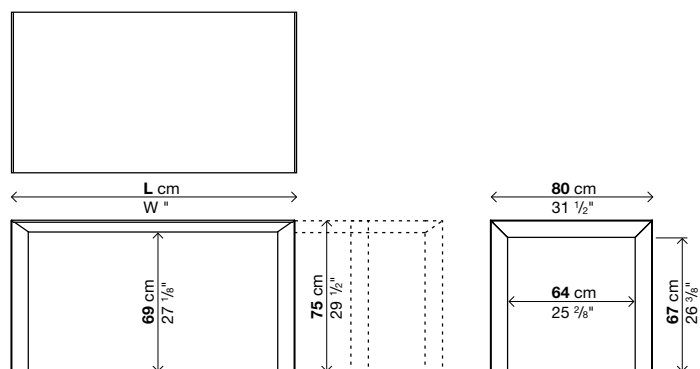

Nori Alucompact® DEPTH 90

Designed by Bartoli Studio

Extending or fixed table with an anodised aluminium structure and Alucompact® layered laminate tops. Alucompact® is a laminate that has been layered at a high temperature by adding sheets of aluminium in the layering phase that give it a strong structural stability. The extending mechanism with two or three extensions makes it possible to easily increase the length of the top while maintaining excellent sturdiness.

Leg finish:

- Anodised aluminium
- Aluminium with white lacquer
- Aluminium with sand grey lacquer
- Aluminium with anthracite grey lacquer
- Aluminium with black lacquer

Finish of top/extensions:

- White laminate
- Sand grey laminate
- Grey laminate
- Anthracite grey laminate
- Black laminate

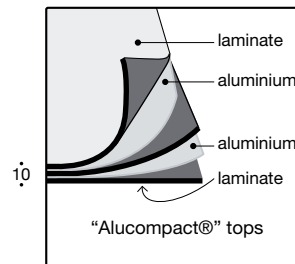

Tables that extend to more than 250 cm have a top that slightly bends, which complies with accepted quality standards.

Extensible (↔)

Code	Length (cm.)	Finish of legs	Finish of top	Vol.
01NOR03	139-176-214	aluminium	laminate	0.39
		lacquer	laminate	
01NOR04 <i>3 rd standard extension</i>	166-203-241-278	aluminium	laminate	0.47
		lacquer	laminate	

Nr. packages 3 (01NOR03) - Nr. packages 4 (01NOR04)

Fixed (||)

Code	Length (cm.)	Finish of legs	Finish of top	Vol.
01NOR03F	139	aluminium	laminate	0.36
		lacquer	laminate	
01NOR04F	166	aluminium	laminate	0.42
		lacquer	laminate	

Nr. packages 1

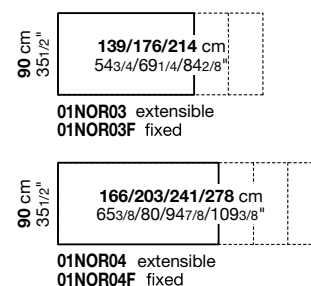
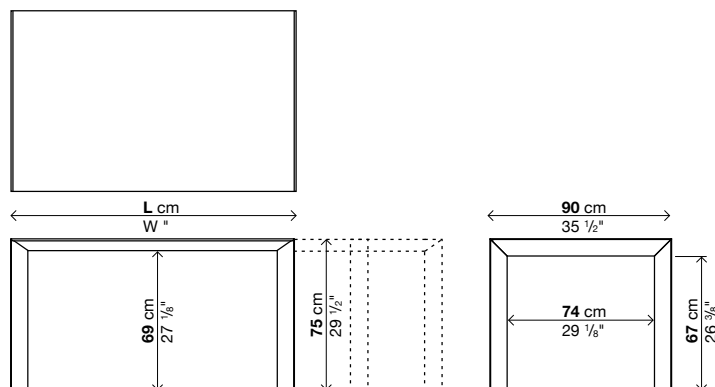

Nori Alucompact® DEPTH 100

Designed by Bartoli Studio

Extending or fixed table with an anodised aluminium structure and Alucompact® layered laminate tops. Alucompact® is a laminate that has been layered at a high temperature by adding sheets of aluminium in the layering phase that give it a strong structural stability. The extending mechanism with two or three extensions makes it possible to easily increase the length of the top while maintaining excellent sturdiness.

Leg finish:

- Anodised aluminium
- Aluminium with white lacquer
- Aluminium with sand grey lacquer
- Aluminium with anthracite grey lacquer
- Aluminium with black lacquer

Finish of top/extensions:

- White laminate
- Sand grey laminate
- Grey laminate
- Anthracite grey laminate
- Black laminate

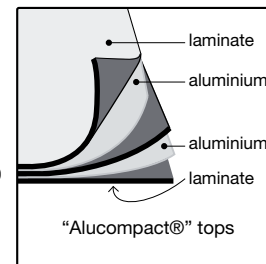

! Please note: sizes marked with (!) have longer delivery times: approximately 8 weeks from order date.

+ It is possible to add a third extension to articles 01NOR05 (increasing the length to 33 cm).

⤿ Tables that extend to more than 250 cm have a top that slightly bends, which complies with accepted quality standards.

Extensible (↔)

Code	Length (cm.)	Finish of legs	Finish of top	Vol.
01NOR05*	166-213-260	aluminium	laminate	0.51
		lacquer	laminate	
01NOR06	209-256-303	aluminium	laminate	0.57
		lacquer	laminate	

Nr. packages 3

(*) 3rd additional extension

Code	Length (cm.)	Finish of top	Vol.
50SUS06A <small>(per art.01NOR05)</small>	33	white	0.03
		sand grey	
		grey	
		anthracite	
		black	

Nr. packages 1

Fixed (||)

Code	Length (cm.)	Finish of legs	Finish of top	Vol.
01NOR05F	166	aluminium	laminate	0.39
		lacquer	laminate	
01NOR07F	189 (!)	aluminium	laminate	0.42
		lacquer	laminate	
01NOR06F	209	aluminium	laminate	0.52
		lacquer	laminate	
01NOR08F	229 (!)	aluminium	laminate	0.54
		lacquer	laminate	

Nr. packages 1

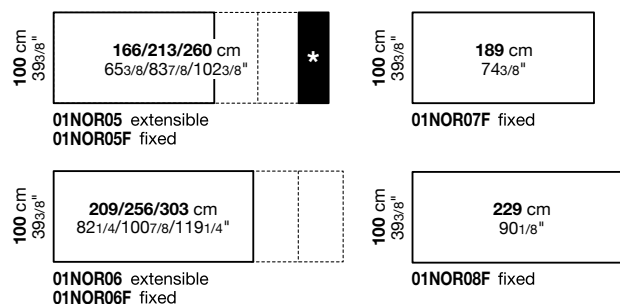
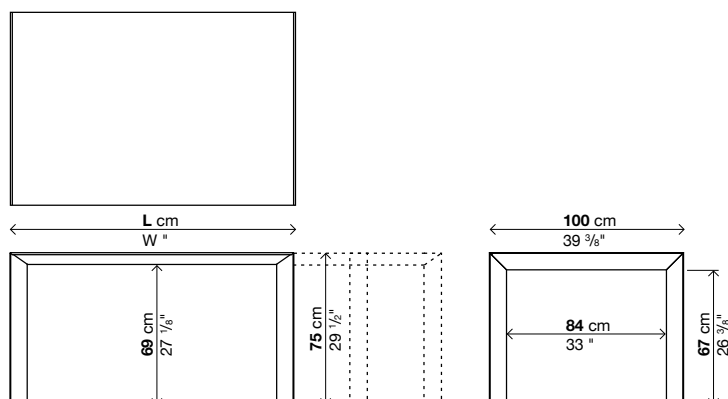

Nori Pure-white

Designed by Bartoli Studio

The larger versions of the Nori table are available with a "Pure-white" finish: entirely white on the surface and along the extremely narrow edge of the top, usually with visible black and aluminium layers. This option enhances the completely minimalist look of these solutions, making them even more surprisingly simple and charmingly elegant.

Leg finish:

Anodised aluminium

Aluminium with white lacquer

Finish of top/extensions:

"Pure-white" laminate (colour reference "White laminate Tuttocolorè")

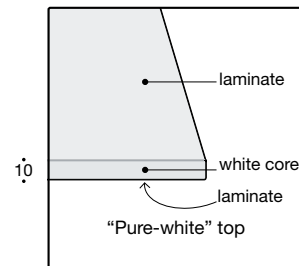

Tables that extend to more than 250 cm have a top that slightly bends, which complies with accepted quality standards.

Extensible (↔)

Code	Length (cm.)	Depth	Finish of legs	Finish of top	Vol.
01NOR03	139-176-214	90	aluminium lacquer	Pure-white Pure-white	0.39
01NOR04 <i>3 rd standard extension</i>	166-203-241-278	90	aluminium lacquer	Pure-white Pure-white	0.47
01NOR06	209-256-303	100	aluminium lacquer	Pure-white Pure-white	0.57

Nr. packages 3 (01NOR03 / 01NOR06) - Nr. packages 4 (01NOR04)

Fixed (||)

Code	Length (cm.)	Depth	Finish of legs	Finish of top	Vol.
01NOR03F	139	90	aluminium lacquer	Pure-white Pure-white	0.36
01NOR04F	166	90	aluminium lacquer	Pure-white Pure-white	0.42
01NOR06F	209	100	aluminium lacquer	Pure-white Pure-white	0.52

Nr. packages 1

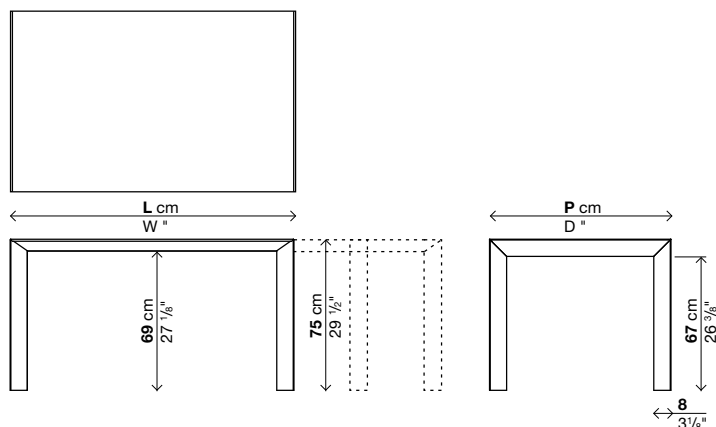

90 cm 35 1/2"	139/176/214 cm 54 3/4/69 1/4/84 2/8"	01NOR03 extensible 01NOR03F fixed
90 cm 35 1/2"	166/203/241/278 cm 65 3/8/80/94 7/8/109 3/8"	01NOR04 extensible 01NOR04F fixed
100 cm 39 3/8"	209/256/303 cm 82 1/4/100 7/8/119 1/4"	01NOR06 extensible 01NOR06F fixed

Nori glass **DEPTH 80**

Designed by Bartoli Studio

Extending or fixed table with an anodised aluminium structure, full-bodied painted top, extensions in Alucompact® layered laminate.

Leg finish:

- Anodised aluminium
- Aluminium with white lacquer
- Aluminium with black lacquer

Finish of top:

- Gloss green glass
- Gloss glass in standard colours: extra white, anthracite, black, titanium
- Gloss glass in RAL/NCS range colours on request
- Matt glass in colours: extra white, anthracite grey, black, titanium

Finish of extensions:

- White laminate
- Sand grey laminate
- Grey laminate
- Anthracite grey laminate
- Black laminate

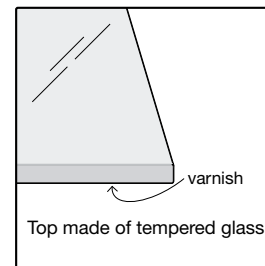

! Please note: variations in shade against selected RAL/NCS sample cannot be avoided and are caused by colour refracting through the thickness of the glass.
Glass in RAL/NCS shades has longer lead times: approximately 8 weeks from order date.

Extensible (↔)

Code	Length (cm.)	Finish of legs	Finish of top	Vol.
01NOR11	114-154-194	aluminium	gloss green	0.27
			gloss in standard	
			gloss in RAL/NCS (I)	
		lacquer	matt glass	
			gloss in standard	
			gloss in RAL/NCS (I)	
01NOR12	139-179-219	aluminium	gloss green	0.32
			gloss in standard	
			gloss in RAL/NCS (I)	
		lacquer	matt glass	
			gloss in standard	
			gloss in RAL/NCS (I)	

Nr. packages 3

Fixed (||)

Code	Length (cm.)	Finish of legs	Finish of top	Vol.
01NOR11F	114	aluminium	gloss green	0.24
			gloss in standard	
			gloss in RAL/NCS (I)	
		lacquer	matt glass	
			gloss in standard	
			gloss in RAL/NCS (I)	
01NOR12F	139	aluminium	gloss green	0.28
			gloss in standard	
			gloss in RAL/NCS (I)	
		lacquer	matt glass	
			gloss in standard	
			gloss in RAL/NCS (I)	

Nr. packages 1

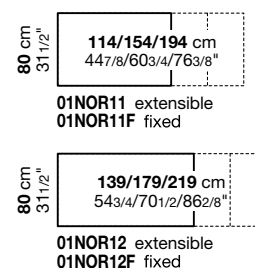
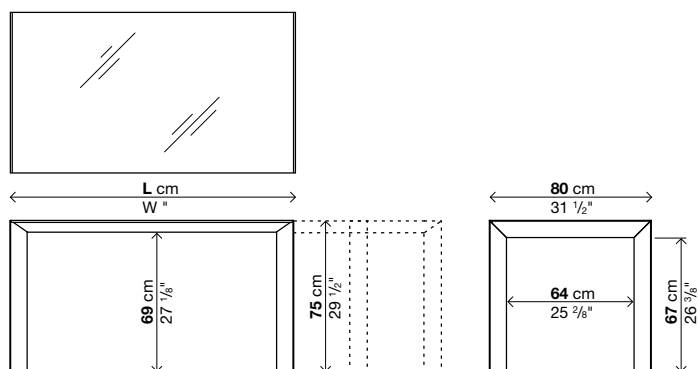

Nori glass **DEPTH 90**

Designed by Bartoli Studio

Extending or fixed table with an anodised aluminium structure, full-bodied painted top, extensions in Alucompact® layered laminate.

Leg finish:

Anodised aluminium
Aluminium with white lacquer
Aluminium with black lacquer

Finish of top:

Gloss green glass
Gloss glass in standard colours: extra white, anthracite, black, titanium
Gloss glass in RAL/NCS range colours on request
Matt glass in colours: extra white, anthracite grey, black, titanium

Finish of extensions:

White laminate
Sand grey laminate
Grey laminate
Anthracite grey laminate
Black laminate

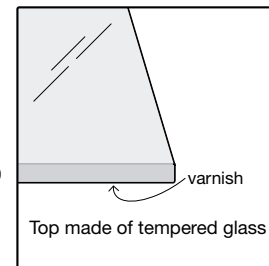

! Please note: variations in shade against selected RAL/NCS sample cannot be avoided and are caused by colour refracting through the thickness of the glass.
Glass in RAL/NCS shades has longer lead times: approximately 8 weeks from order date.

☺ Tables that extend to more than 250 cm have a top that slightly bends, which complies with accepted quality standards.

Extensible (↔)

Code	Length (cm.)	Finish of legs	Finish of top	Vol.
01NOR13	139-176-214	aluminium	gloss green	0.39
			gloss in standard	
		lacquer	gloss in RAL/NCS (!)	
			matt glass	
01NOR14	166-203-241-278	aluminium	gloss green	0.47
			gloss in standard	
		lacquer	gloss in RAL/NCS (!)	
			matt glass	
<i>3 rd standard extension</i>			gloss in standard	
			gloss in RAL/NCS (!)	
			matt glass	

Nr. packages 3 (01NOR13) - Nr. packages 4 (01NOR14)

Fixed (||)

Code	Length (cm.)	Finish of legs	Finish of top	Vol.
01NOR13F	139	aluminium	gloss green	0.36
			gloss in standard	
		lacquer	gloss in RAL/NCS (!)	
			matt glass	
01NOR14F	166	aluminium	gloss green	0.42
			gloss in standard	
		lacquer	gloss in RAL/NCS (!)	
			matt glass	
			gloss in standard	
			gloss in RAL/NCS (!)	
			matt glass	

Nr. packages 1

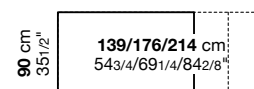
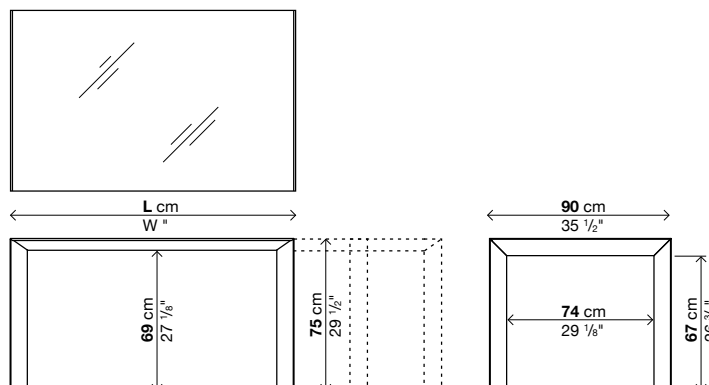

01NOR13 extensible
01SUS13F fixed

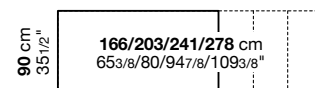

01SUS14 extensible
01SUS14F fixed

Nori glass DEPTH 100

Designed by Bartoli Studio

Extending or fixed table with an anodised aluminium structure, full-bodied painted top, extensions in Alucompact® layered laminate.

Leg finish:

Anodised aluminium
Aluminium with white lacquer
Aluminium with black lacquer

Finish of top:

Gloss green glass
Gloss glass in standard colours: extra white, anthracite, black, titanium
Gloss glass in RAL/NCS range colours on request
Matt glass in colours: extra white, anthracite grey, black, titanium

Finish of extensions:

White laminate
Sand grey laminate
Grey laminate
Anthracite grey laminate
Black laminate

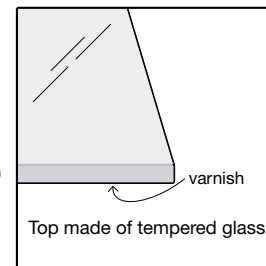

! Please note: variations in shade against selected RAL/NCS sample cannot be avoided and are caused by colour refracting through the thickness of the glass.

Glass in RAL/NCS shades and sizes marked with (!) have longer lead times: approximately 8 weeks from order date.

+ It is possible to add a third extension to articles 01NOR15 (increasing the length to 33 cm).

⤿ Tables that extend to more than 250 cm have a top that slightly bends, which complies with accepted quality standards.

Extensible (↔)

Code	Length (cm.)	Finish of legs	Finish of top	Vol.
01NOR15*	166-213-260	aluminium	gloss green	0.51
			gloss in standard	
			gloss in RAL/NCS (!)	
		lacquer	matt glass	
			gloss in standard	
			gloss in RAL/NCS (!)	
01NOR17	209-256-303	aluminium	matt glass	0.57
			gloss in standard	
			gloss in RAL/NCS (!)	
		lacquer	gloss in standard	
			gloss in RAL/NCS (!)	
			matt glass	

Nr. packages 3

(*) 3rd additional extension

Code	Length (cm.)	Finish of top	Vol.
50SUS06A (per art.01NOR15)	33	white	0.03
		sand grey	
		grey	
		anthracite	
		black	

Nr. packages 1

Fixed (||)

Code	Length (cm.)	Finish of legs	Finish of top	Vol.
01NOR15F	166	aluminium	gloss green	0.39
			gloss in standard	
			gloss in RAL/NCS (!)	
		lacquer	matt glass	
			gloss in standard	
			gloss in RAL/NCS (!)	
01NOR18F	189 (!)	aluminium	matt glass	0.42
			gloss in standard	
			gloss in RAL/NCS (!)	
		lacquer	gloss in standard	
			gloss in RAL/NCS (!)	
			matt glass	
01NOR17F	209	aluminium	gloss in standard	0.52
			gloss in RAL/NCS (!)	
			matt glass	
		lacquer	gloss in standard	
			gloss in RAL/NCS (!)	
			matt glass	
01NOR19F	229 (!)	aluminium	gloss in standard	0.54
			gloss in RAL/NCS	
			matt glass	
		lacquer	gloss in standard	
			gloss in RAL/NCS	
			matt glass	

Nr. packages 1

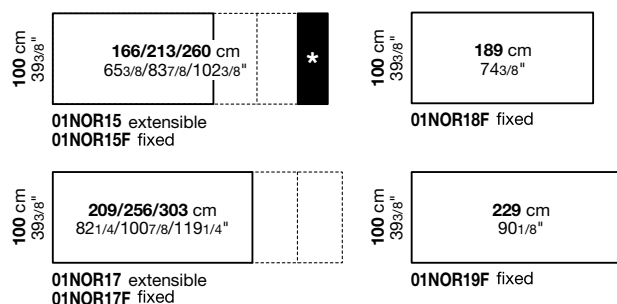
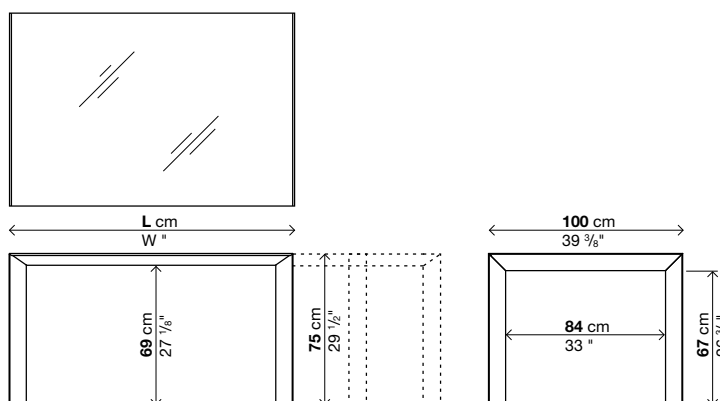

Nori Honeycomb

Designed by Bartoli Studio

Extending or fixed table with an anodised aluminium structure and honeycomb tops. By observing a cross-section of the top one can see that it is composed of a honeycombed aluminium structure. These modern panels are used to construct aeroplane nacelles and are both lightweight and very resistant to flexion and compression, despite the fact that they are "air-filled". Also available in uni-colour option.

Leg finish:

Anodised aluminium

Aluminium with wengé lacquer

Aluminium with grey oak lacquer

Finish of top/extensions:

Oak

Wengé stained Oak

Grey Oak

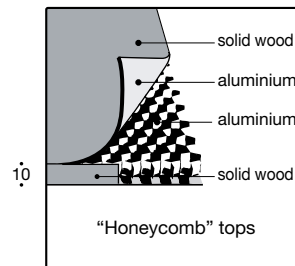

! Please note: sizes marked with (!) have longer delivery times: approximately 8 weeks from order date.

☺ Tables that extend to more than 250 cm have a top that slightly bends, which complies with accepted quality standards.

Extensible (↔)

Code	Length (cm.)	Depth	Finish of legs	Finish of top	Vol.
01NOR21	114-154-194	80	aluminium	oak	0.24
				wengé stained	
				grey oak	
01NOR22	139-179-219	90	aluminium	oak	0.28
				wengé stained	
				grey oak	
01NOR23	166-213-260	90	aluminium	oak	0.41
				wengé stained	
				grey oak	
01NOR24	166-213-260	100	aluminium	oak	0.47
				wengé stained	
				grey oak	
01NOR25	209-256-303	100	aluminium	oak	0.52
				wengé stained	
				grey oak	

Nr. packages 1

Fixed (||)

Code	Length (cm.)	Depth	Finish of legs	Finish of top	Vol.
01NOR21F	114	80	aluminium	oak	0.24
				wengé stained	
				grey oak	
01NOR22F	139	90	aluminium	oak	0.28
				wengé stained	
				grey oak	
01NOR23F	166	90	aluminium	oak	0.36
				wengé stained	
				grey oak	
01NOR24F	166	100	aluminium	oak	0.39
				wengé stained	
				grey oak	
01NOR26F	189 (!)	100	aluminium	oak	0.42
				wengé stained	
				grey oak	
01NOR25F	209	100	aluminium	oak	0.52
				wengé stained	
				grey oak	
01NOR27F	229 (!)	100	aluminium	oak	0.54
				wengé stained	
				grey oak	

Nr. packages 1

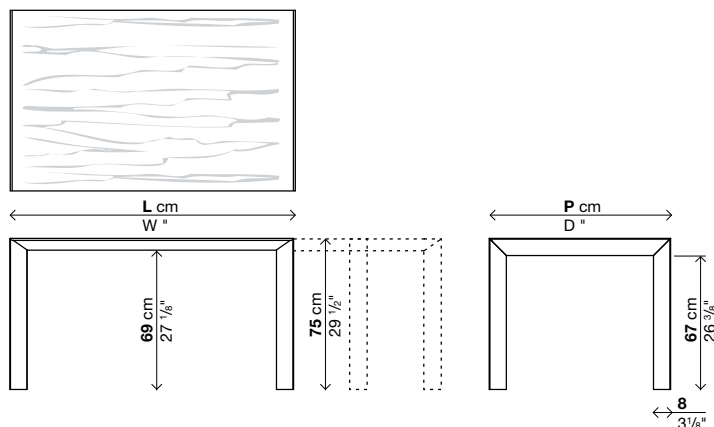

Finishes

Finiture metallo

Metal finish / Metallausführungen / Acabados metal / Finitions métal



Alluminio anodizzato / Anodised aluminium / Eloxiertes Aluminium / Aluminio anodizado / Aluminium anodisé



Bianco / White / Weiß / Blanco / Blanc

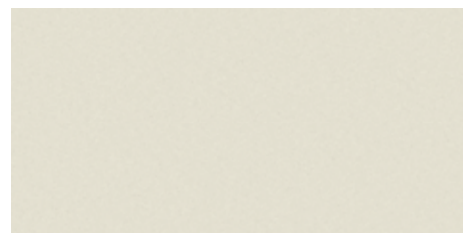

Grigio sabbia / Sand grey / Sandgrau / Gris arena / Gris sable



Grigio / Grey / Grau / Gris / Gris



Grigio antracite / Anthracite grey / Grau anthrazit / Gris antracita / Gris anthracite



Nero / Black / Schwarz / Negro / Noir

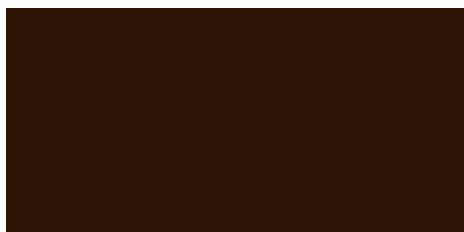

Color wengé / Wengé lacquer / Farbton Wengé lackiert / Color wengé / Couleur wengé



Color rovere grigio / Grey oak lacquer / Farbton Graues Eichen / Color roble gris / Couleur chêne gris

Finishes

Laminati Alucompact®

Alucompact® laminates / Lamine Alucompact® / Laminados Alucompact® / Stratifiés Alucompact®

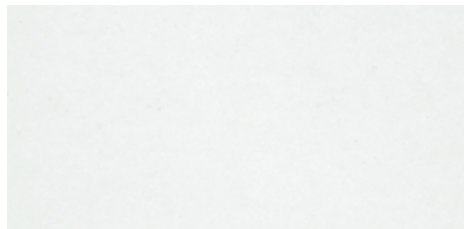

Bianco / White / Weiß / Blanco / Blanc

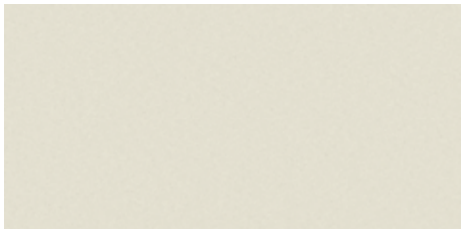

Grigio sabbia / Sand grey / Sandgrau / Gris arena / Gris sable



Grigio / Grey / Grau / Gris / Gris



Grigio antracite / Anthracite grey / Grau anthrazit / Gris antracita / Gris anthracite



Nero / Black / Schwarz / Negro / Noir

Laminato Pure-white

Pure-white laminate / Laminat Pure-white / Laminado Pure-white / Stratifié Pure-white

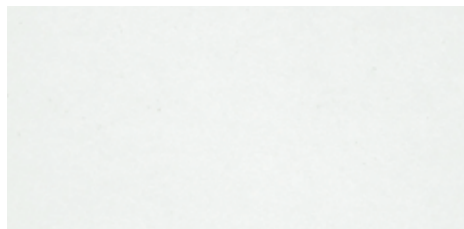

Bianco / White / Weiß / Blanco / Blanc

Essenze legno

Wood finishes / Holzarten / Esencias de madera / Essences du bois



Rovere naturale / Natural oak / Naturfarbene Eiche / Roble natural / Rouvre naturel

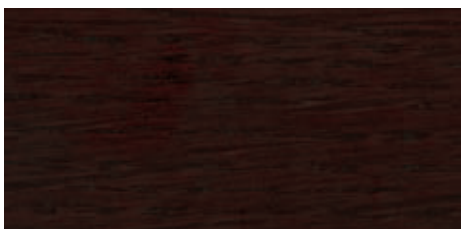

Rovere tinto wengé / Wengé stained oak / Wengé gebeizte Eiche / Roble teñido wengé / Rouvre teinté wengé

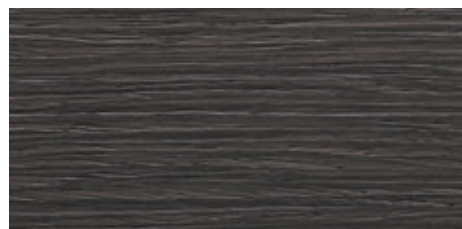

Rovere tinto grigio / Grey stained oak / Graue gebeizte Eiche / Roble teñido gris / Rouvre teinté gris

Finishes

Vetri lucidi temperati

Tempered gloss glass / Glänzende Sicherheitsgläser / Cristales brillantes templados / Verres brillants trempés



VE Verde retroverniciato / Green back-painted / Grünes, an der Rückseite lackiert / Verde retrobarnizado / Vert laqué au dessous



XB Extra white retroverniciato / Extra white back-painted / Extraweißes, an der Rückseite lackiert / Extra white retrobarnizado / Extra blanc laqué au dessous



V3 Titanio retroverniciato / Titanium back-painted / Titan, an der Rückseite lackiert / Titanio retrobarnizado / Titane laqué au dessous



V1 Grigio antracite retroverniciato / Anthracite grey back-painted / Anthrazitgraues, an der Rückseite lackiert / Antracita retrobarnizado / Gris anthracite laqué au dessous

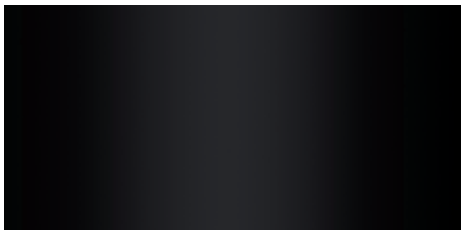

V2 Nero retroverniciato / Black back-painted / Schwarz, an der Rückseite lackiert / Negro retrobarnizado / Noir laqué au dessous

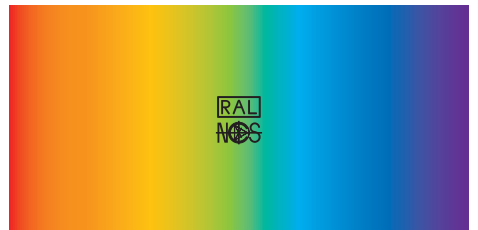

Colori scala RAL/NCS / RAL/NCS range colours / Farben der Skala RAL/NCS / Colores escala RAL/NCS / Coloris palette RAL/NCS

Vetri opachi temperati

Tempered matt glass / Matte Sicherheitsgläser / Cristales mates templados / Verres mats trempés

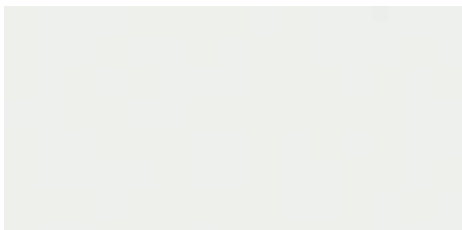

XBM Extra white retroverniciato / Extra white back-painted / Extraweißes, an der Rückseite lackiert / Extra white retrobarnizado / Extra blanc laqué au dessous

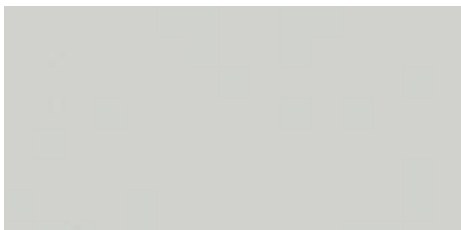

V3M Titanio retroverniciato / Titanium back-painted / Titan, an der Rückseite lackiert / Titanio retrobarnizado / Titane laqué au dessous



V1M Grigio antracite retroverniciato / Anthracite grey back-painted / Anthrazitgraues, an der Rückseite lackiert / Antracita retrobarnizado / Gris anthracite laqué au dessous

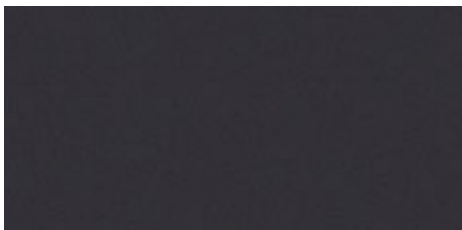

V2M Nero retroverniciato / Black back-painted / Schwarz, an der Rückseite lackiert / Negro retrobarnizado / Noir laqué au dessous